





01 *round* STONES

These loose crystal elements feature a round view-side and have a range of different cuts such as the XILION Chaton – the most brilliant cut on the market. The majority of Round Stones are pointed on the reverse side, making them easy to use with metal claw settings or with die-cast, metal alloys that have pre-set cavities into which they can be either pasted or glued.

round STONES

COLOURS & EFFECTS

Colours



Effects

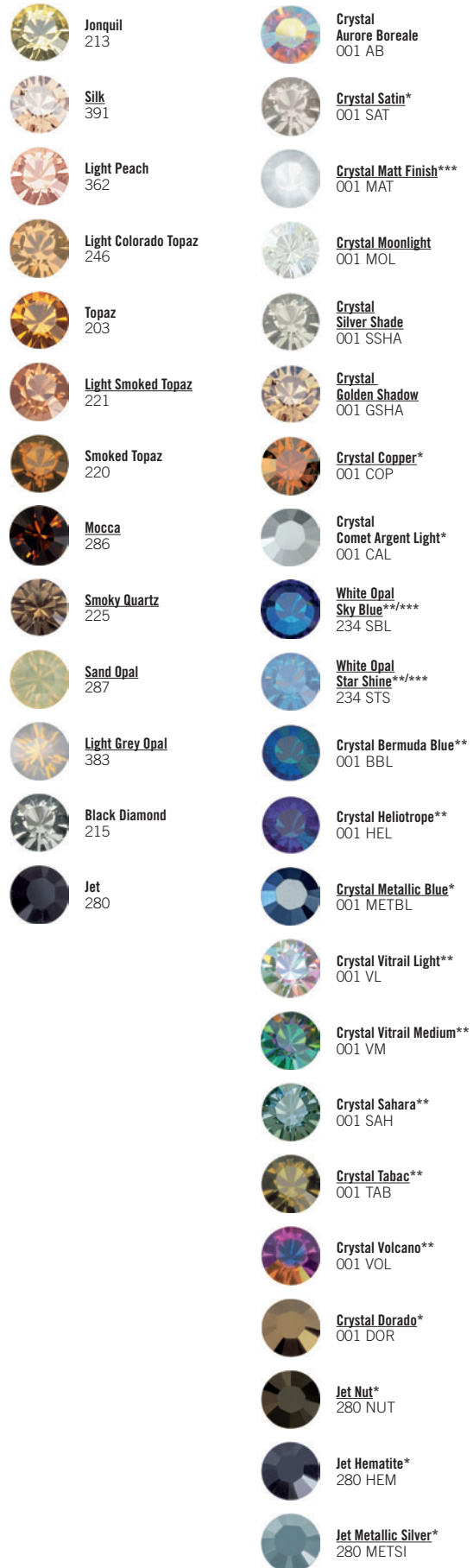

Classic Colours [Exclusive Colours](#)

Numerical Order

001	Crystal	204	Amethyst	234	White Opal	361	Light Azure
001 AB	Crystal Aurore Boreale	205	Emerald	234 SBL	White Opal Sky Blue**/****	362	Light Peach
001 BBL	Crystal Bermuda Blue**	206	Sapphire	234 STS	White Opal Star Shine**/****	371	Violet
001 CAL	Crystal Comet Argent Light*	207	Montana	236	Hyacinth	379	Indicolite
001 COP	Crystal Copper*	208	Siam	237	Fireopal****	383	Light Grey Opal
001 DOR	Crystal Dorado*	209	Rose	238	Chrysolite	385	Lime
001 GSHA	Crystal Golden Shadow	211	Light Sapphire	241	Garnet	390	Pacific Opal
001 HEL	Crystal Heliotope**	212	Light Amethyst	243	Capri Blue	391	Silk
001 MAT	Crystal Matt Finish***	213	Jonquil	246	Light Colorado Topaz	393	Palace Green Opal
001 METBL	Crystal Metallic Blue*	214	Peridot	267	Turquoise	394	Caribbean Blue Opal
001 MOL	Crystal Moonlight	215	Black Diamond	277	Purple Velvet	395	Rose Water Opal
001 SAH	Crystal Sahara**	217	Indian Sapphire	280	Jet	396	Dark Red Coral
001 SAT	Crystal Satin*	220	Smoked Topaz	280 HEM	Jet Hematite*	397	Mint Alabaster
001 SSHA	Crystal Silver Shade	221	Light Smoked Topaz	280 METSI	Jet Metallic Silver*	501	Ruby
001 TAB	Crystal Tabac**	223	Light Rose	280 NUT	Jet Nut*	502	Fuchsia
001 VL	Crystal Vitrail Light**	225	Smoky Quartz	281	White Alabaster	515	Burgundy
001 VM	Crystal Vitrail Medium**	226	Light Topaz	286	Mocca	539	Tanzanite
001 VOL	Crystal Volcano**	227	Light Siam	287	Sand Opal	542	Padparadscha
202	Aquamarine	228	Olivine	319	Vintage Rose	550	Khaki
203	Topaz	229	Blue Zircon	360	Erinite		

Alphabetical Order

Amethyst (204)	Crystal Satin* (001 SAT)	Khaki (550)	Purple Velvet (277)
Aquamarine (202)	Crystal Silver Shade (001 SSHA)	Light Amethyst (212)	Rose (209)
Black Diamond (215)	Crystal Tabac** (001 TAB)	Light Azure (361)	Rose Water Opal (395)
Blue Zircon (229)	Crystal Vitrail Light** (001 VL)	Light Colorado Topaz (246)	Ruby (501)
Burgundy (515)	Crystal Vitrail Medium** (001 VM)	Light Grey Opal (383)	Sand Opal (287)
Capri Blue (243)	Crystal Volcano** (001 VOL)	Light Peach (362)	Sapphire (206)
Caribbean Blue Opal (394)	Dark Red Coral (396)	Light Rose (223)	Siam (208)
Chrysolite (238)	Emerald (205)	Light Sapphire (211)	Silk (391)
Crystal (001)	Erinite (360)	Light Siam (227)	Smoked Topaz (220)
Crystal Aurore Boreale (001 AB)	Fuchsia (502)	Light Smoked Topaz (221)	Smoky Quartz (225)
Crystal Bermuda Blue** (001 BBL)	Garnet (241)	Light Topaz (226)	Tanzanite (539)
Crystal Comet Argent Light* (001 CAL)	Hyacinth (236)	Lime (385)	Topaz (203)
Crystal Copper* (001 COP)	Fireopal**** (237)	Mint Alabaster (397)	Turquoise (267)
Crystal Dorado* (001 DOR)	Indian Sapphire (217)	Mocca (286)	Vintage Rose (319)
Crystal Golden Shadow (001 GSHA)	Indicolite (379)	Montana (207)	Violet (371)
Crystal Heliotope** (001 HEL)	Jet (280)	Olivine (228)	White Alabaster (281)
Crystal Matt Finish*** (001 MAT)	Jet Hematite* (280 HEM)	Pacific Opal (390)	White Opal (234)
Crystal Metallic Blue* (001 METBL)	Jet Metallic Silver* (280 METSI)	Padparadscha (542)	White Opal Sky Blue**/**** (234 SBL)
Crystal Moonlight (001 MOL)	Jet Nut* (280 NUT)	Palace Green Opal (393)	White Opal Star Shine**/**** (234 STS)
Crystal Sahara** (001 SAH)	Jonquil (213)	Peridot (214)	

Classic Colours: This colour range offers a wide choice of traditional Swarovski crystal colours.

Exclusive Colours: This colour range is offered exclusively by Swarovski.

The standard assortment of colours and effects may vary according to the product group.

Slight changes in shades are unavoidable and may vary according to cut and shape.

* Crystals are not resistant to plating and similar processing.

** Crystals are only resistant to plating if they are foiled.



*** Effects only available as special productions.

**** Fireopal is only available on Fancy Stone 4470.

Summary



1 2 3



1028
 PP 6, 7, 8, 9, 10, 11, 12, 13, 14, 15, 16,
 17, 18, 19, 20, 21, 22, 23, 24, 25, 26, 27,
 28, 29, 30, 31, 32
 SS 18, 19, 20, 21, 22, 24, 26, 28, 29, 30,
 34, 35, 38, 39, 40, 45, 47, 48, 50

1100
 PP 2, 3, 4, 5



1122
 SS 17, 24, 29, 34, 39, 47
 12, 14, 16, 18 mm

1128
 PP 32
 SS 29, 39

1200
 SS 24, 29, 34, 39, 60

1201
 27 mm

1357
 SS 17, 29, 39, 45

Round Stones

1028 XILION Chaton

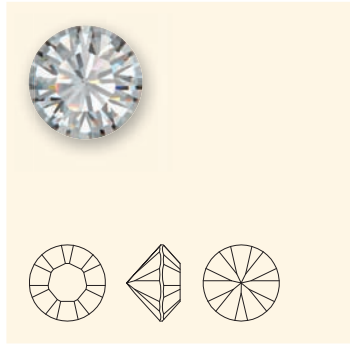

Colour

- Crystal (001)
- Crystal F (001)
- Crystal AB F (001 AB)
- Crystal Copper F (001 COP)
- Crystal Dorado F (001 DOR)
- Crystal Golden Shadow F (001 GSHA)
- Crystal Metallic Blue F (001 METBL)
- Crystal Moonlight F (001 MOL)
- Crystal Silver Shade F (001 SSHA)
- Jet (280)
- Jet F (280)
- Jet Hematite (280 HEM)
- Amethyst F (204)
- Aquamarine F (202)
- Black Diamond F (215)
- Blue Zircon F (229)
- Burgundy F (515)
- Capri Blue F (243)
- Caribbean Blue Opal F (394)
- Chrysolite F (238)
- Dark Red Coral F (396)
- Emerald F (205)
- Erinite F (360)
- Fuchsia F (502)
- Garnet F (241)
- Hyacinth F (236)
- Indian Sapphire F (217)
- Indicolite F (379)
- Jonquil F (213)
- Khaki F (550)
- Light Amethyst F (212)
- Light Azure F (361)
- Light Colorado Topaz F (246)
- Light Grey Opal F (383)
- Light Peach F (362)
- Light Rose F (223)
- Light Sapphire F (211)
- Light Siam F (227)
- Light Smoked Topaz F (221)





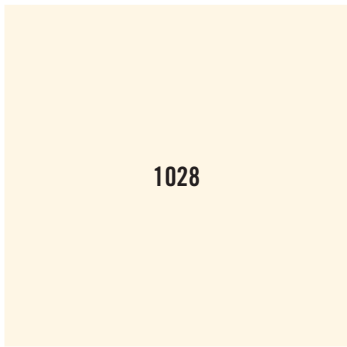





















Size	PP 6	PP 7	PP 8	PP 9	PP 10	PP 11	PP 12	PP 13	PP 14	PP 15	PP 16	PP 17	PP 18	PP 19	PP 20	PP 21	PP 22	PP 23	PP 24	PP 25	PP 26	PP 27	PP 28	PP 29	PP 30	PP 31	PP 32	
Crystal (001)				■	■	■		■	■				■			■			■								■	■
Crystal F (001)	■	■	■	■	■	■	■	■	■	■	■	■	■	■	■	■	■	■	■	■	■	■	■	■	■	■	■	■
Crystal AB F (001 AB)	■	■	■	■	■	■	■	■	■	■	■	■	■	■	■	■	■	■	■	■	■	■	■	■	■	■	■	■
Crystal Copper F (001 COP)				■	■	■		■	■				■			■			■								■	■
Crystal Dorado F (001 DOR)				■	■	■		■	■				■			■			■								■	■
Crystal Golden Shadow F (001 GSHA)				■	■	■		■	■			■	■			■			■								■	■
Crystal Metallic Blue F (001 METBL)				■	■	■		■	■				■			■			■								■	■
Crystal Moonlight F (001 MOL)				■	■	■		■	■				■			■			■								■	■
Crystal Silver Shade F (001 SSHA)				■	■	■		■	■				■			■			■								■	■
Jet (280)	■	■	■	■	■	■	■	■	■	■	■	■	■	■	■	■	■	■	■	■	■	■	■	■	■	■	■	■
Jet F (280)	■	■	■	■	■	■	■	■	■	■	■	■	■	■	■	■	■	■	■	■	■	■	■	■	■	■	■	■
Jet Hematite (280 HEM)				■	■	■		■	■				■			■			■								■	■
Amethyst F (204)	■	■	■	■	■	■	■	■	■	■	■	■	■	■	■	■	■	■	■	■	■	■	■	■	■	■	■	■
Aquamarine F (202)	■	■	■	■	■	■	■	■	■	■	■	■	■	■	■	■	■	■	■	■	■	■	■	■	■	■	■	■
Black Diamond F (215)	■	■	■	■	■	■	■	■	■	■	■	■	■	■	■	■	■	■	■	■	■	■	■	■	■	■	■	■
Blue Zircon F (229)				■	■	■		■	■				■			■			■								■	■
Burgundy F (515)				■	■	■		■	■				■			■			■								■	■
Capri Blue F (243)				■	■	■		■	■				■			■			■								■	■
Caribbean Blue Opal F (394)				■	■	■		■	■				■			■			■								■	■
Chrysolite F (238)				■	■	■		■	■				■			■			■								■	■
Dark Red Coral F (396)				■	■	■		■	■				■			■			■								■	■
Emerald F (205)	■	■	■	■	■	■	■	■	■	■	■	■	■	■	■	■	■	■	■	■	■	■	■	■	■	■	■	■
Erinite F (360)				■	■	■		■	■				■			■			■								■	■
Fuchsia F (502)	■	■	■	■	■	■	■	■	■	■	■	■	■	■	■	■	■	■	■	■	■	■	■	■	■	■	■	■
Garnet F (241)				■	■	■		■	■				■			■			■								■	■
Hyacinth F (236)				■	■	■		■	■				■			■			■								■	■
Indian Sapphire F (217)				■	■	■		■	■				■			■			■								■	■
Indicolite F (379)				■	■	■		■	■				■			■			■								■	■
Jonquil F (213)	■	■	■	■	■	■	■	■	■	■	■	■	■	■	■	■	■	■	■	■	■	■	■	■	■	■	■	■
Khaki F (550)				■	■	■		■	■				■			■			■								■	■
Light Amethyst F (212)	■	■	■	■	■	■	■	■	■	■	■	■	■	■	■	■	■	■	■	■	■	■	■	■	■	■	■	■
Light Azure F (361)				■	■	■		■	■				■			■			■								■	■
Light Colorado Topaz F (246)	■	■	■	■	■	■	■	■	■	■	■	■	■	■	■	■	■	■	■	■	■	■	■	■	■	■	■	■
Light Grey Opal F (383)				■	■	■		■	■				■			■			■								■	■
Light Peach F (362)				■	■	■		■	■				■			■			■								■	■
Light Rose F (223)	■	■	■	■	■	■	■	■	■	■	■	■	■	■	■	■	■	■	■	■	■	■	■	■	■	■	■	■
Light Sapphire F (211)	■	■	■	■	■	■	■	■	■	■	■	■	■	■	■	■	■	■	■	■	■	■	■	■	■	■	■	■
Light Siam F (227)	■	■	■	■	■	■	■	■	■	■	■	■	■	■	■	■	■	■	■	■	■	■	■	■	■	■	■	■
Light Smoked Topaz F (221)				■	■	■		■	■				■			■			■								■	■

Round Stones



1028

Colour

-  Light Topaz F (226)
-  Lime F (385)
-  Mint Alabaster F (397)
-  Mocca F (286)
-  Montana F (207)
-  Olivine F (228)
-  Pacific Opal F (390)
-  Padparadscha F (542)
-  Palace Green Opal F (393)
-  Peridot F (214)
-  Purple Velvet F (277)
-  Rose F (209)
-  Rose Water Opal F (395)
-  Ruby F (501)
-  Sand Opal F (287)
-  Sapphire F (206)
-  Siam F (208)
-  Silk F (391)
-  Smoked Topaz F (220)
-  Smoky Quartz F (225)
-  Tanzanite F (539)
-  Topaz F (203)
-  Turquoise (267)
-  Vintage Rose F (319)
-  Violet F (371)
-  White Alabaster F (281)
-  White Opal F (234)

Size	PP 6	PP 7	PP 8	PP 9	PP 10	PP 11	PP 12	PP 13	PP 14	PP 15	PP 16	PP 17	PP 18	PP 19	PP 20	PP 21	PP 22	PP 23	PP 24	PP 25	PP 26	PP 27	PP 28	PP 29	PP 30	PP 31	PP 32
Light Topaz F (226)				■	■	■		■	■				■			■			■							■	■
Lime F (385)				■	■	■		■	■				■			■			■							■	■
Mint Alabaster F (397)				■	■	■		■	■				■			■			■							■	■
Mocca F (286)				■	■	■		■	■				■			■			■							■	■
Montana F (207)	■	■	■	■	■	■	■	■	■	■	■	■	■	■	■	■	■	■	■	■	■	■	■	■	■	■	■
Olivine F (228)	■	■	■	■	■	■	■	■	■	■	■	■	■	■	■	■	■	■	■	■	■	■	■	■	■	■	■
Pacific Opal F (390)				■	■	■		■	■				■			■			■							■	■
Padparadscha F (542)				■	■	■		■	■				■			■			■							■	■
Palace Green Opal F (393)				■	■	■		■	■				■			■			■							■	■
Peridot F (214)	■	■	■	■	■	■	■	■	■	■	■	■	■	■	■	■	■	■	■	■	■	■	■	■	■	■	■
Purple Velvet F (277)				■	■	■		■	■				■			■			■							■	■
Rose F (209)	■	■	■	■	■	■	■	■	■	■	■	■	■	■	■	■	■	■	■	■	■	■	■	■	■	■	■
Rose Water Opal F (395)					■			■	■				■			■			■							■	■
Ruby F (501)				■	■	■		■	■				■			■			■							■	■
Sand Opal F (287)				■	■	■		■	■				■			■			■							■	■
Sapphire F (206)	■	■	■	■	■	■	■	■	■	■	■	■	■	■	■	■	■	■	■	■	■	■	■	■	■	■	■
Siam F (208)	■	■	■	■	■	■	■	■	■	■	■	■	■	■	■	■	■	■	■	■	■	■	■	■	■	■	■
Silk F (391)				■	■	■		■	■				■			■			■							■	■
Smoked Topaz F (220)	■	■	■	■	■	■	■	■	■	■	■	■	■	■	■	■	■	■	■	■	■	■	■	■	■	■	■
Smoky Quartz F (225)				■	■	■		■	■				■			■			■							■	■
Tanzanite F (539)	■	■	■	■	■	■	■	■	■	■	■	■	■	■	■	■	■	■	■	■	■	■	■	■	■	■	■
Topaz F (203)	■	■	■	■	■	■	■	■	■	■	■	■	■	■	■	■	■	■	■	■	■	■	■	■	■	■	■
Turquoise (267)				■	■	■		■	■				■			■			■							■	■
Vintage Rose F (319)				■	■	■		■	■				■			■			■							■	■
Violet F (371)	■	■	■	■	■	■	■	■	■	■	■	■	■	■	■	■	■	■	■	■	■	■	■	■	■	■	■
White Alabaster F (281)				■	■	■		■	■				■			■			■							■	■
White Opal F (234)				■	■	■		■	■				■			■			■							■	■

Round Stones

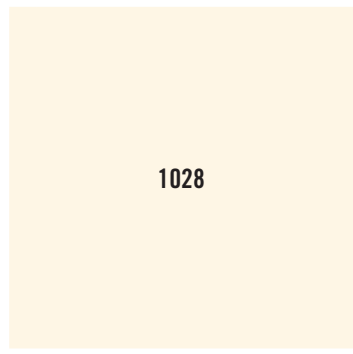

1028

Colour

- Crystal (001)
- Crystal F (001)
- Crystal AB F (001 AB)
- Crystal Copper F (001 COP)
- Crystal Dorado F (001 DOR)
- Crystal Golden Shadow F (001 GSHA)
- Crystal Metallic Blue F (001 METBL)
- Crystal Moonlight F (001 MOL)
- Crystal Silver Shade F (001 SSHA)
- Jet (280)
- Jet Hematite (280 HEM)

- Amethyst F (204)
- Aquamarine F (202)
- Black Diamond F (215)
- Blue Zircon F (229)
- Burgundy F (515)
- Capri Blue F (243)
- Caribbean Blue Opal F (394)
- Chrysolite F (238)
- Dark Red Coral F (396)
- Emerald F (205)
- Erinite F (360)
- Fuchsia F (502)
- Garnet F (241)
- Hyacinth F (236)
- Indian Sapphire F (217)
- Indicolite F (379)
- Jonquil F (213)
- Khaki F (550)
- Light Amethyst F (212)
- Light Azure F (361)
- Light Colorado Topaz F (246)
- Light Grey Opal F (383)
- Light Peach F (362)
- Light Rose F (223)
- Light Sapphire F (211)
- Light Siam F (227)
- Light Smoked Topaz F (221)
- Light Topaz F (226)

Size	SS 18	SS 19	SS 20	SS 21	SS 22	SS 24	SS 26	SS 28	SS 29	SS 30	SS 34	SS 35	SS 38	SS 39	SS 40	SS 45	SS 47	SS 48	SS 50
Crystal (001)	■	■				■			■		■			■					
Crystal F (001)	■	■	■	■	■	■	■	■	■	■	■	■	■	■	■	■	■	■	■
Crystal AB F (001 AB)	■	■	■	■	■	■	■	■	■	■	■	■	■	■	■	■	■	■	■
Crystal Copper F (001 COP)	■	■				■			■		■			■					
Crystal Dorado F (001 DOR)	■	■				■			■		■			■					
Crystal Golden Shadow F (001 GSHA)	■	■				■			■		■			■					
Crystal Metallic Blue F (001 METBL)	■	■				■			■		■			■					
Crystal Moonlight F (001 MOL)	■	■				■			■		■			■					
Crystal Silver Shade F (001 SSHA)	■	■				■			■		■			■					
Jet (280)	■	■			■	■		■	■	■	■		■	■	■	■	■		
Jet Hematite (280 HEM)	■	■			■	■		■	■	■	■		■	■	■	■	■		
Amethyst F (204)		■			■	■		■	■		■			■		■	■		
Aquamarine F (202)	■	■	■		■	■		■	■	■	■		■	■	■	■	■		
Black Diamond F (215)	■	■	■		■	■		■	■	■	■		■	■	■	■	■		
Blue Zircon F (229)	■	■				■			■		■			■					
Burgundy F (515)	■	■				■			■		■			■					
Capri Blue F (243)	■	■				■			■		■			■					
Caribbean Blue Opal F (394)	■	■				■			■		■			■					
Chrysolite F (238)	■	■				■			■		■			■					
Dark Red Coral F (396)	■	■				■			■		■			■					
Emerald F (205)	■	■				■			■		■			■					
Erinite F (360)	■	■				■			■		■			■					
Fuchsia F (502)	■	■			■	■		■	■		■			■		■	■		
Garnet F (241)	■	■				■			■		■			■					
Hyacinth F (236)	■	■				■			■		■			■					
Indian Sapphire F (217)	■	■				■			■		■			■					
Indicolite F (379)	■	■				■			■		■			■					
Jonquil F (213)	■	■				■			■		■			■					
Khaki F (550)	■	■				■			■		■			■					
Light Amethyst F (212)	■	■				■			■		■			■					
Light Azure F (361)	■	■				■			■		■			■					
Light Colorado Topaz F (246)	■	■	■			■	■		■	■	■		■	■		■	■		
Light Grey Opal F (383)	■	■				■			■		■			■					
Light Peach F (362)	■	■				■			■		■			■					
Light Rose F (223)	■	■	■			■			■		■			■		■	■		
Light Sapphire F (211)	■	■	■			■			■		■			■		■	■		
Light Siam F (227)	■	■				■			■		■			■					
Light Smoked Topaz F (221)	■	■				■			■		■			■					
Light Topaz F (226)	■	■				■			■		■			■					

Round Stones

1028		Size																			
		SS 18	SS 19	SS 20	SS 21	SS 22	SS 24	SS 26	SS 28	SS 29	SS 30	SS 34	SS 35	SS 38	SS 39	SS 40	SS 45	SS 47	SS 48	SS 50	
Colour																					
	Lime F (385)		■				■		■		■				■						
	Mint Alabaster F (397)			■			■		■		■				■						
	Mocca F (286)			■			■		■		■				■						
	Montana F (207)			■			■		■		■				■						
	Olivine F (228)			■			■		■		■				■						
	Pacific Opal F (390)	■		■			■		■		■				■						
	Padparadscha F (542)	■		■			■		■		■				■						
	Palace Green Opal F (393)			■			■		■		■				■						
	Peridot F (214)			■	■		■		■	■	■				■		■	■			
	Purple Velvet F (277)			■			■		■		■				■						
	Rose F (209)	■		■	■		■		■	■	■				■		■	■			
	Rose Water Opal F (395)			■			■		■		■				■						
	Ruby F (501)			■			■		■		■				■						
	Sand Opal F (287)			■			■		■		■				■						
	Sapphire F (206)			■			■	■	■		■				■		■	■			
	Siam F (208)	■		■	■		■	■	■		■				■		■	■			
	Silk F (391)			■			■		■		■				■						
	Smoked Topaz F (220)	■		■			■		■		■				■						
	Smoky Quartz F (225)			■			■		■		■				■						
	Tanzanite F (539)			■	■		■		■		■				■						
	Topaz F (203)	■		■			■	■	■		■				■		■	■			
	Turquoise (267)			■			■		■		■				■						
	Vintage Rose F (319)			■			■		■		■				■						
	Violet F (371)			■			■		■		■				■						
	White Alabaster F (281)			■			■		■		■				■						
	White Opal F (234)			■			■		■		■				■						

Round Stones

1100

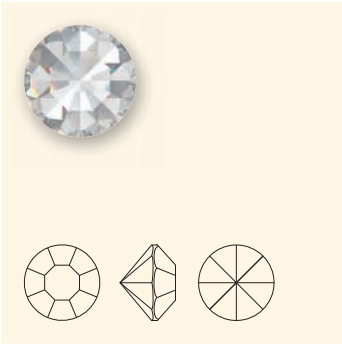

Size
PP 2
PP 3
PP 4
PP 5

Colour

Crystal F (001)	■	■	■	■
Jet (280)		■	■	■
Jet F (280)		■	■	■
Amethyst F (204)		■	■	■
Aquamarine F (202)		■	■	■
Black Diamond F (215)		■	■	■
Chrysolite F (238)		■	■	■
Emerald F (205)		■	■	■
Fuchsia F (502)		■	■	■
Indicolite F (379)	<i>New!</i>	■	■	■
Jonquil F (213)		■	■	■
Light Amethyst F (212)		■	■	■
Light Colorado Topaz F (246)		■	■	■
Light Peach F (362)	<i>New!</i>	■	■	■
Light Rose F (223)		■	■	■
Light Sapphire F (211)		■	■	■
Light Siam F (227)		■	■	■
Montana F (207)		■	■	■
Olivine F (228)		■	■	■
Peridot F (214)		■	■	■
Rose F (209)		■	■	■
Sapphire F (206)		■	■	■
Siam F (208)		■	■	■
Smoked Topaz F (220)		■	■	■
Topaz F (203)		■	■	■
Violet F (371)		■	■	■

Round Stones

1122 Rivoli Chaton

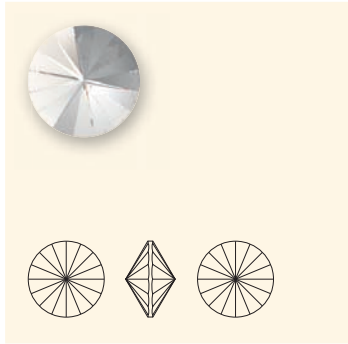

Colour	SS 17	SS 24	SS 29	SS 34	SS 39	SS 47	12 mm	14 mm	16 mm	18 mm
Crystal F (001)	■	■	■	■	■	■	■	■	■	■
Crystal AB F (001 AB)	■	■	■	■	■	■	■	■	■	■
Crystal Copper F (001 COP)	■	■	■	■	■	■	■	■	■	■
Crystal Golden Shadow F (001 GSHA)	■	■	■	■	■	■	■	■	■	■
Crystal Silver Shade F (001 SSHA)	■	■	■	■	■	■	■	■	■	■
Crystal Vitrail Light F (001 VL)	■	■	■	■	■	■	■	■	■	■
Crystal Vitrail Medium F (001 VM)	■	■	■	■	■	■	■	■	■	■
Jet (280)	■	■	■	■	■	■	■	■	■	■
Jet Hematite (280 HEM)	■	■	■	■	■	■	■	■	■	■
Amethyst F (204)	■	■	■	■	■	■	■	■	■	■
Aquamarine F (202)	■	■	■	■	■	■	■	■	■	■
Black Diamond F (215)	■	■	■	■	■	■	■	■	■	■
Chrysolite F (238)	■	■	■	■	■	■	■	■	■	■
Emerald F (205)	■	■	■	■	■	■	■	■	■	■
Fuchsia F (502)	■	■	■	■	■	■	■	■	■	■
Light Amethyst F (212)	■	■	■	■	■	■	■	■	■	■
Light Colorado Topaz F (246)	■	■	■	■	■	■	■	■	■	■
Light Peach F (362)	■	■	■	■	■	■	■	■	■	■
Light Rose F (223)	■	■	■	■	■	■	■	■	■	■
Light Sapphire F (211)	■	■	■	■	■	■	■	■	■	■
Light Siam F (227)	■	■	■	■	■	■	■	■	■	■
Montana F (207)	■	■	■	■	■	■	■	■	■	■
Olivine F (228)	■	■	■	■	■	■	■	■	■	■
Padparadscha F (542)	■	■	■	■	■	■	■	■	■	■
Peridot F (214)	■	■	■	■	■	■	■	■	■	■
Rose F (209)	■	■	■	■	■	■	■	■	■	■
Sapphire F (206)	■	■	■	■	■	■	■	■	■	■
Siam F (208)	■	■	■	■	■	■	■	■	■	■
Smoked Topaz F (220)	■	■	■	■	■	■	■	■	■	■
Tanzanite F (539)	■	■	■	■	■	■	■	■	■	■
Topaz F (203)	■	■	■	■	■	■	■	■	■	■
Violet F (371)	■	■	■	■	■	■	■	■	■	■

Round Stones

1128

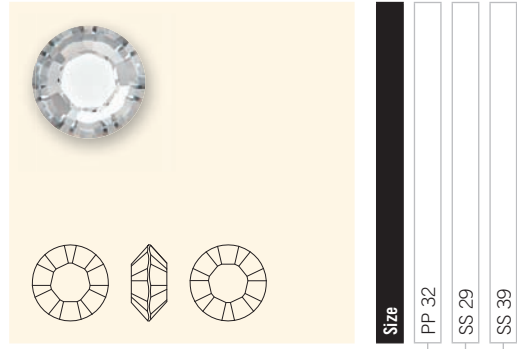

Colour	PP 32	SS 29	SS 39
Crystal (001)	■	■	■
Crystal Golden Shadow (001 GSHA)		■	
Jet (280)	■	■	■
Amethyst (204)	■	■	■
Aquamarine (202)	■	■	■
Black Diamond (215)	■	■	■
Blue Zircon (229)	■	■	■
Emerald (205)	■	■	■
Fuchsia (502)		■	
Jonquil (213)	■	■	■
Light Amethyst (212)	■	■	■
Light Colorado Topaz (246)	■	■	■
Light Rose (223)	■	■	■
Light Sapphire (211)	■	■	■
Peridot (214)	■	■	■
Rose (209)	■	■	■
Sapphire (206)	■	■	■
Siam (208)	■	■	■
Smoked Topaz (220)	■	■	■
Tanzanite (539)		■	
Topaz (203)	■	■	■
Violet (371)		■	

1200

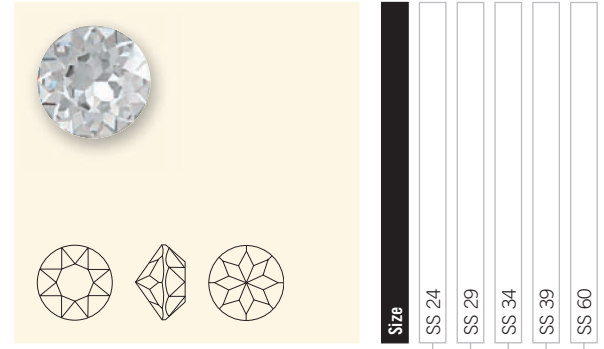

Colour	SS 24	SS 29	SS 34	SS 39	SS 60
Crystal F (001)	■	■	■	■	■

Round Stones

1201

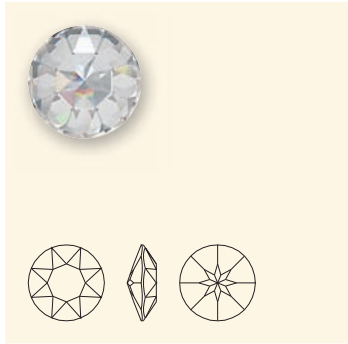

Size
27 mm

Colour

- Crystal (001)
- Crystal F (001)
- Crystal AB F (001 AB)
- Jet (280)
- Aquamarine F (202)
- Chrysolite F (238)
- Fuchsia F (502)
- Light Colorado Topaz F (246)
- Rose F (209)

1357 Brilliant Cut



Size
SS 17
SS 29
SS 39
SS 45

Colour

- Crystal (001)
- Crystal F (001)

Round Stones

Product Details

<<<

Article Size	Packing Unit = Minimum Order Quantity in Pieces	Base Quantity Unit for Special Productions of Effects in Pieces	Base Quantity Unit for Special Productions of Effects in Packs	Average Net Weight in Gram per Packing Unit Crystal (001)	Average Gross Weight in Gram per Packing Unit Crystal (001)
1028					
PP 6	1,440	14,400	10	2.40	13.29
PP 7	1,440	14,400	10	2.70	13.59
PP 8	1,440	14,400	10	3.87	14.76
PP 9	1,440	8,640	6	3.83	14.72
PP 10	1,440	8,640	6	4.32	15.21
PP 11	1,440	8,640	6	5.50	16.39
PP 12	1,440	8,640	6	6.60	17.49
PP 13	1,440	8,640	6	8.28	19.17
PP 14	1,440	8,640	6	9.10	19.99
PP 15	1,440	8,640	6	9.92	20.81
PP 16	1,440	8,640	6	11.70	22.59
PP 17	1,440	5,760	4	13.91	24.80
PP 18	1,440	5,760	4	15.84	26.73
PP 19	1,440	5,760	4	16.80	27.69
PP 20	1,440	5,760	4	20.30	31.19
PP 21	1,440	5,760	4	22.18	33.07
PP 22	1,440	5,760	4	24.79	35.68
PP 23	1,440	5,760	4	26.59	37.48
PP 24	1,440	5,760	4	32.89	43.78
PP 25	1,440	4,320	3	35.83	46.72
PP 26	1,440	4,320	3	38.94	49.83
PP 27	1,440	4,320	3	42.26	53.15
PP 28	1,440	2,880	2	47.25	58.14
PP 29	1,440	2,880	2	51.63	62.52
PP 30	1,440	2,880	2	54.46	65.35
PP 31	1,440	2,880	2	60.85	71.74
PP 32	1,440	2,880	2	69.00	79.89
SS 18	1,440	2,880	2	80.93	91.82
SS 19	1,440	2,880	2	81.00	91.89
SS 20	720	1,440	2	53.50	64.39
SS 21	720	1,440	2	58.50	69.39
SS 22	720	1,440	2	63.00	73.89
SS 24	720	1,440	2	87.50	98.39
SS 26	360	1,440	4	52.00	62.89
SS 28	360	1,440	4	62.50	73.39
SS 29	360	1,440	4	67.00	77.89
SS 30	360	1,440	4	72.00	82.89
SS 34	144	1,440	10	40.55	51.44
SS 35	144	1,440	10	43.50	54.39
SS 38	144	1,440	10	57.50	68.39
SS 39	144	1,440	10	62.80	73.69
SS 40	144	1,440	10	68.00	78.89
SS 45	144	720	5	126.72	153.36
SS 47	144	720	5	139.68	167.42
SS 48	144	720	5	155.52	183.26
SS 50	144	720	5	185.18	214.16

Round Stones

Article Size	Packing Unit = Minimum Order Quantity in Pieces	Base Quantity Unit for Special Productions of Effects in Pieces	Base Quantity Unit for Special Productions of Effects in Packs	Average Net Weight in Gram per Packing Unit Crystal (001)	Average Gross Weight in Gram per Packing Unit Crystal (001)
1100					
PP 2	1,440	21,600	15	1.00	11.87
PP 3	1,440	21,600	15	1.25	12.12
PP 4	1,440	21,600	15	1.50	12.37
PP 5	1,440	14,400	10	2.00	12.87
1122					
SS 17	1,440	4,320	3	57.50	68.37
SS 24	720	2,160	3	56.00	66.87
SS 29	720	1,440	2	92.50	103.37
SS 34	360	1,080	3	69.18	80.05
SS 39	144	576	4	44.29	55.16
SS 47	288	576	2	189.14	215.85
12 mm	144	432	3	118.60	142.21
14 mm	144	288	2	199.61	225.93
16 mm	144	288	2	82.94	110.73
18 mm	72	288	4	216.72	243.99
1128					
PP 32	1,440	2,880	2	68.99	79.88
SS 29	360	1,440	4	63.75	74.64
SS 39	144	864	6	59.00	69.89
1200					
SS 24	360	1,080	3	39.78	50.65
SS 29	360	1,440	4	64.15	75.02
SS 34	144	720	5	45.46	56.33
SS 39	288	576	2	119.95	147.90
SS 60	72	216	3	165.60	186.21
1201					
27 mm	24	72	3	207.84	246.55
1357					
SS 17	1,440	4,320	3	64.10	74.97
SS 29	360	1,080	3	64.70	75.57
SS 39	144	432	3	62.10	72.97
SS 45	144	432	3	111.50	131.52